



Wrocław
University
of Science
and Technology

Criteria for car safety assessment

Crashworthiness

- **Crashworthiness** insures vehicle structural integrity and its ability to absorb crash energy with minimal diminution of survivable space.
- Restraint systems limit occupant motion mitigating injuries that may result from contact with vehicle interior during sudden acceleration conditions.
- Both structural crashworthiness and occupant protection technologies are multi-disciplinary and highly specialized, including complex technical fields spanning from the areas of mechanics to biological sciences.
- The applications will help manufacturers and design engineers to apprise the different approaches available today and their use and suitability as efficient design tools.

Test Companies and Programs

- **NHTSA**- National Highway Traffic Safety Administration
- **USNCAP**-New Car Assessment Program
- **IIHS**- Insurance Institute for Highway Safety
- **FMVSS**- The Federal Motor Vehicle Safety Standards
- **EEVC**-The European Enhanced Vehicle-Safety Committee
- **Euro NCAP**- New Car Assessment Program
- **ECE R European Regulations**- United Nations Economic Commission for Europe

Crash Test (ISO 6813)



(a)



(b)



(c)



(d)

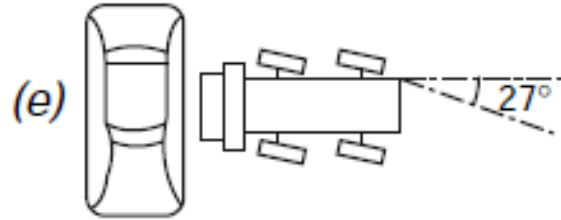

(e)

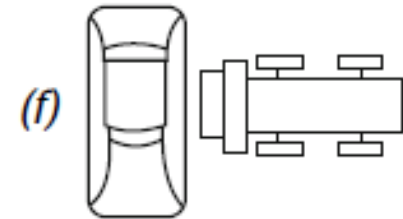

(f)

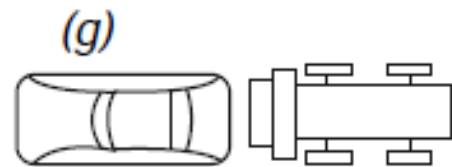

(g)

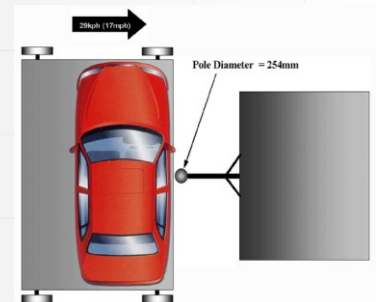
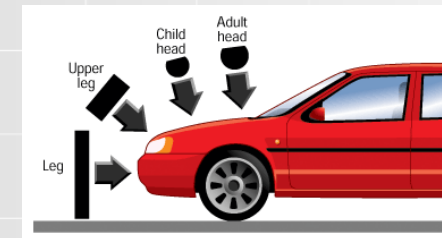
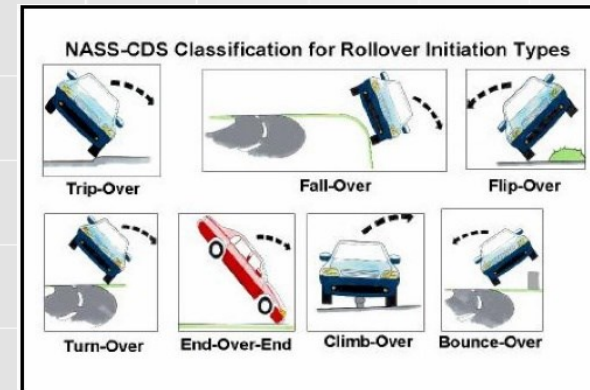
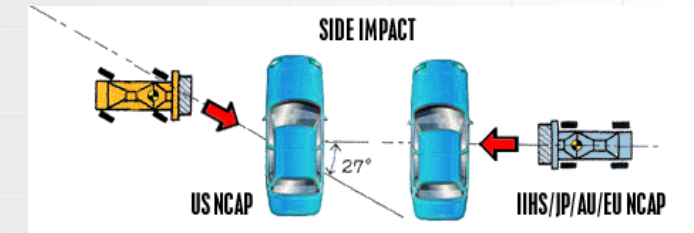
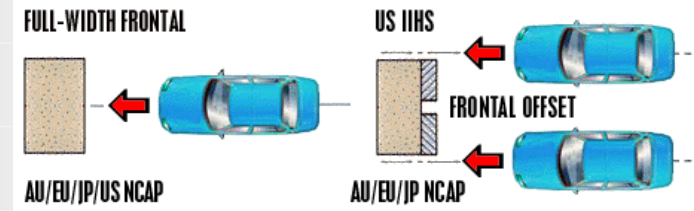

Sensor Test Number	Actual Speed (mph)	Type / Configuration
1	14.0	90 Barrier
10	5.8	
11	35.3	
12	10.5	
13	7.4	
2	13.8	8" Pole Offset Left
3	34.9	
4	26.5	F-F 25% Overlap Taurus → Sable
5	25.2	30 L.F.-R.F. Taurus → Sable
15	35.3/ 35.4	90 Front NHTSA MDB

Sensor Test Number	Actual Speed (mph)	Type / Configuration
16	21.8/ 21.6	90 Front-Side (Both Moving)
8	25.3	Front-Rear Taurus → Escort
9	24.1	Sable → Sable
14	17.7	Bumper Over-Ride 50% Offset Right
6	27.7	30 L.F. Corner F. Center Taurus → Sable
7	37.5	30 R.F. Corner Side Wheel Sable → Taurus

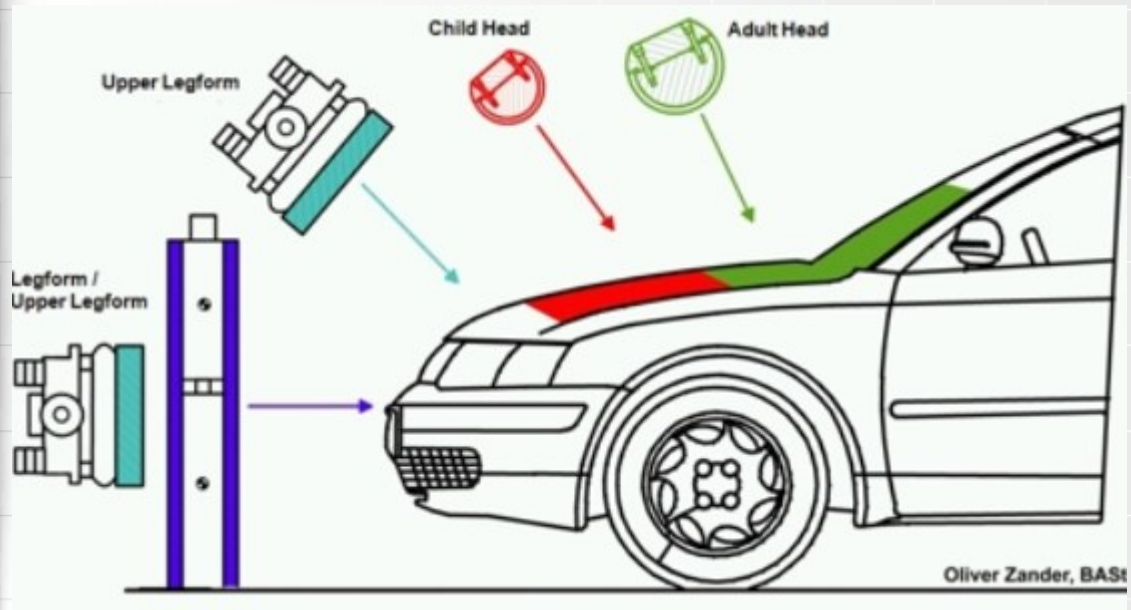

Crash Testing ATD

- During each test the dummy injury is always measured and calculated. Relationships between forces and moments which act on the dummy relate to the human body's durability and hardness, which was determined during the Cadaver Project
- The injuries criteria as well as the empirical equations describing injuries were established by means of barbecue and cadaver project. On the basis of barbecue and cadaver projects, engineers managed to describe several types of injuries for whole body of occupant.

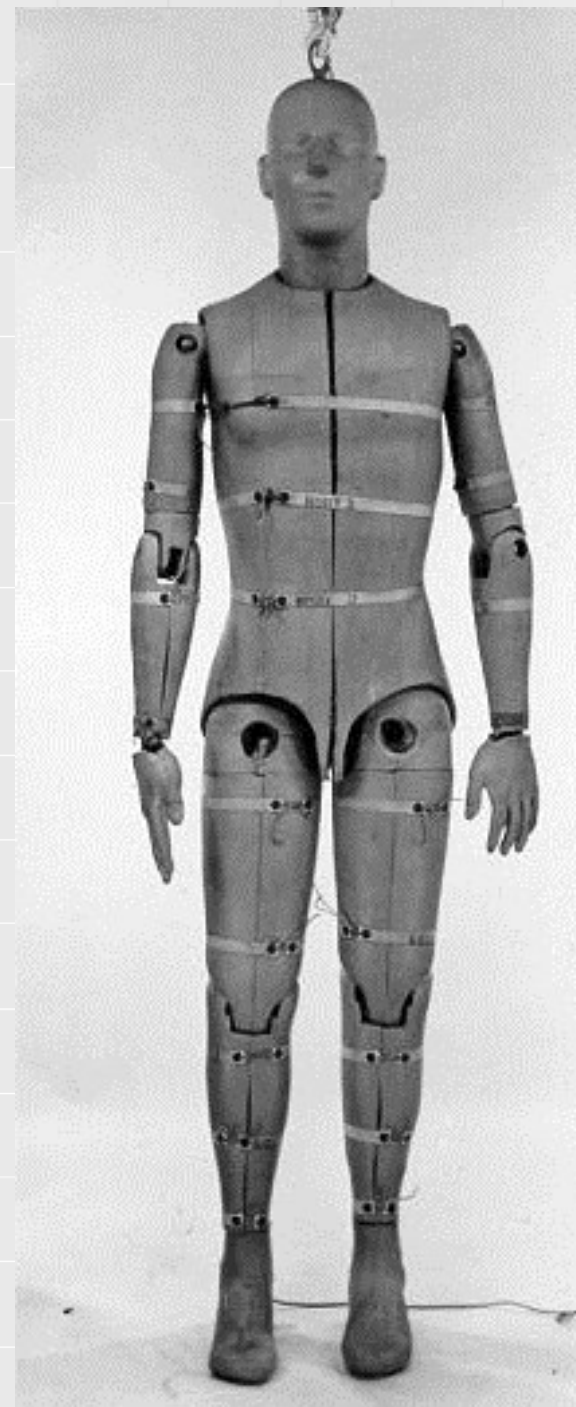

ATD measurement

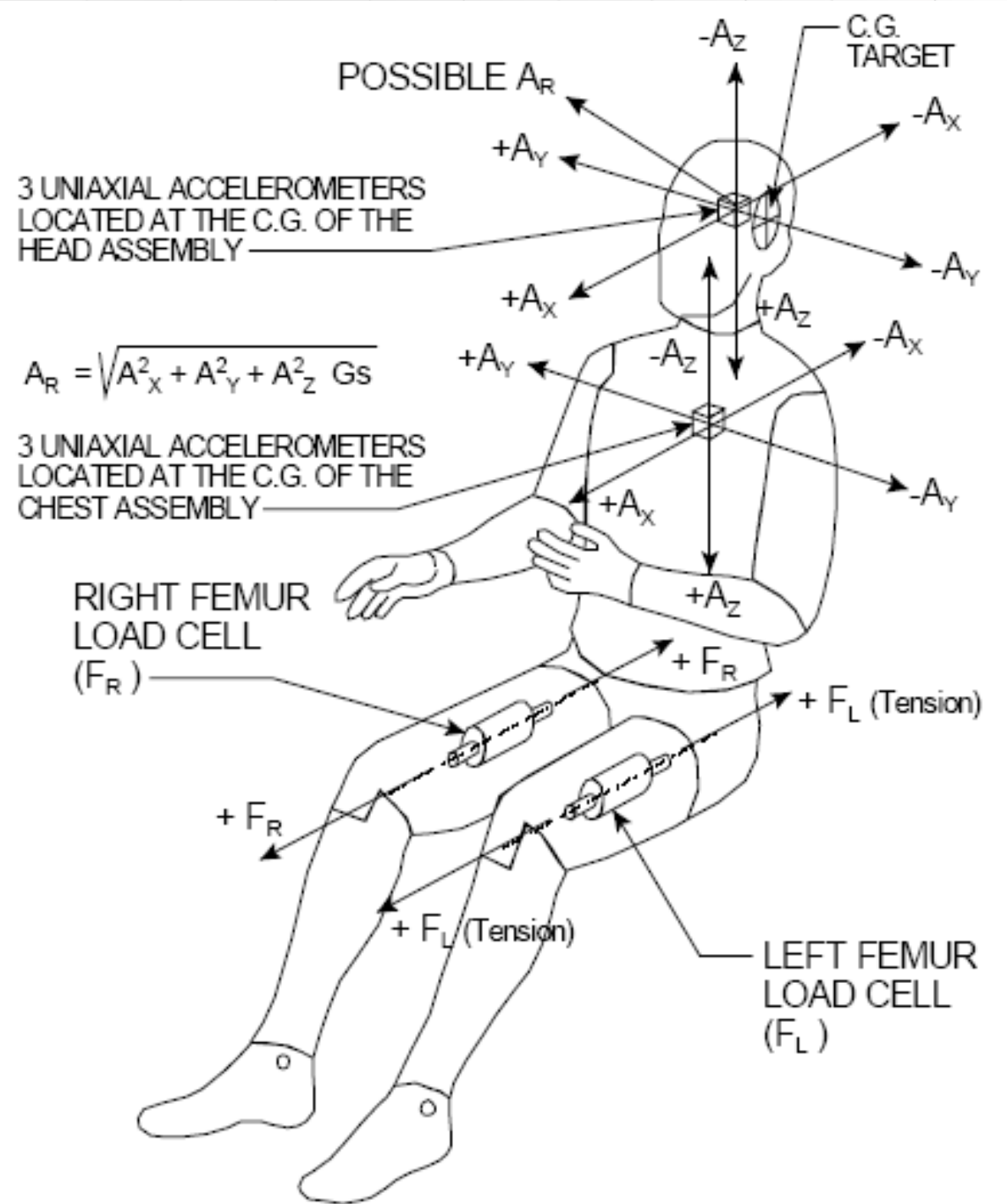

HYBRID III	Height cm	Weight Kg
Male dummy	168	77
"Big brother"	188	100
Female dummy	152	50
Children dummy 3 years old	54,6	15
Children dummy 6 years old	63,5	21



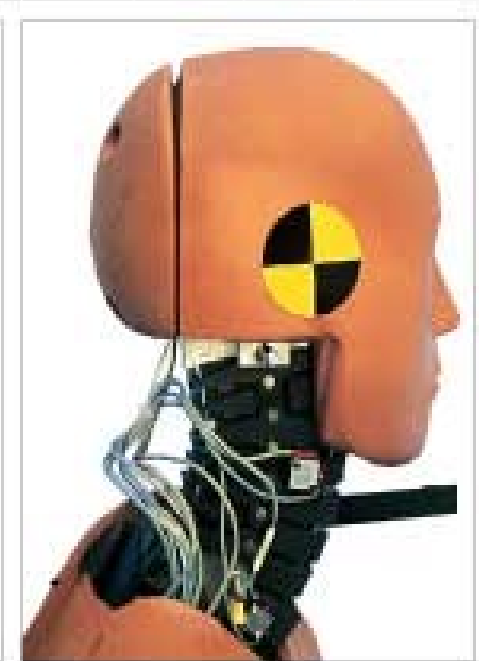
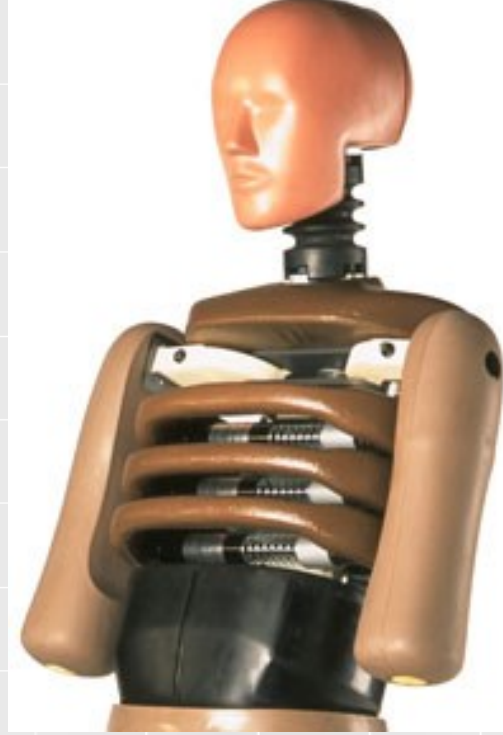

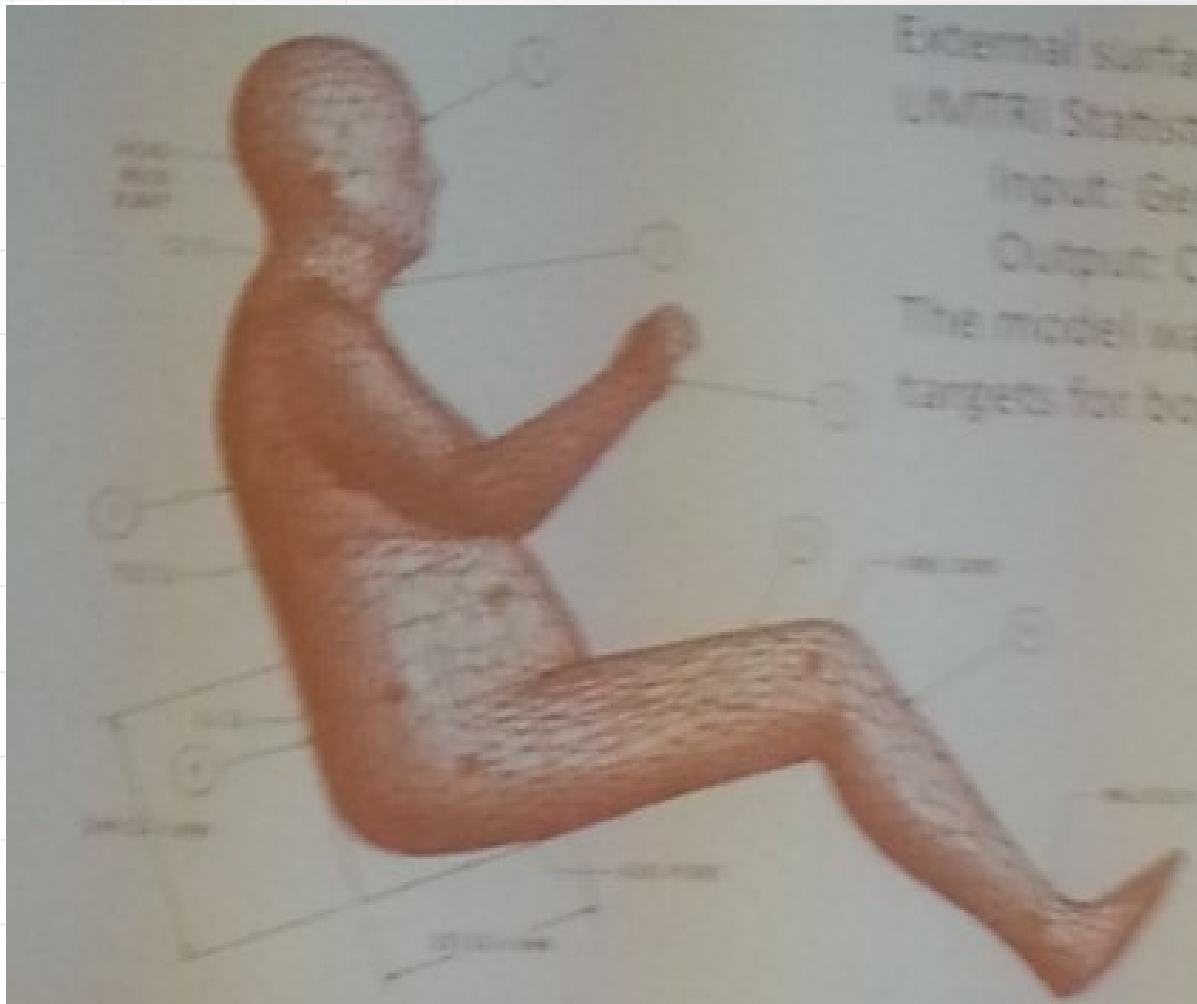



Thor dummy



THOR dummy

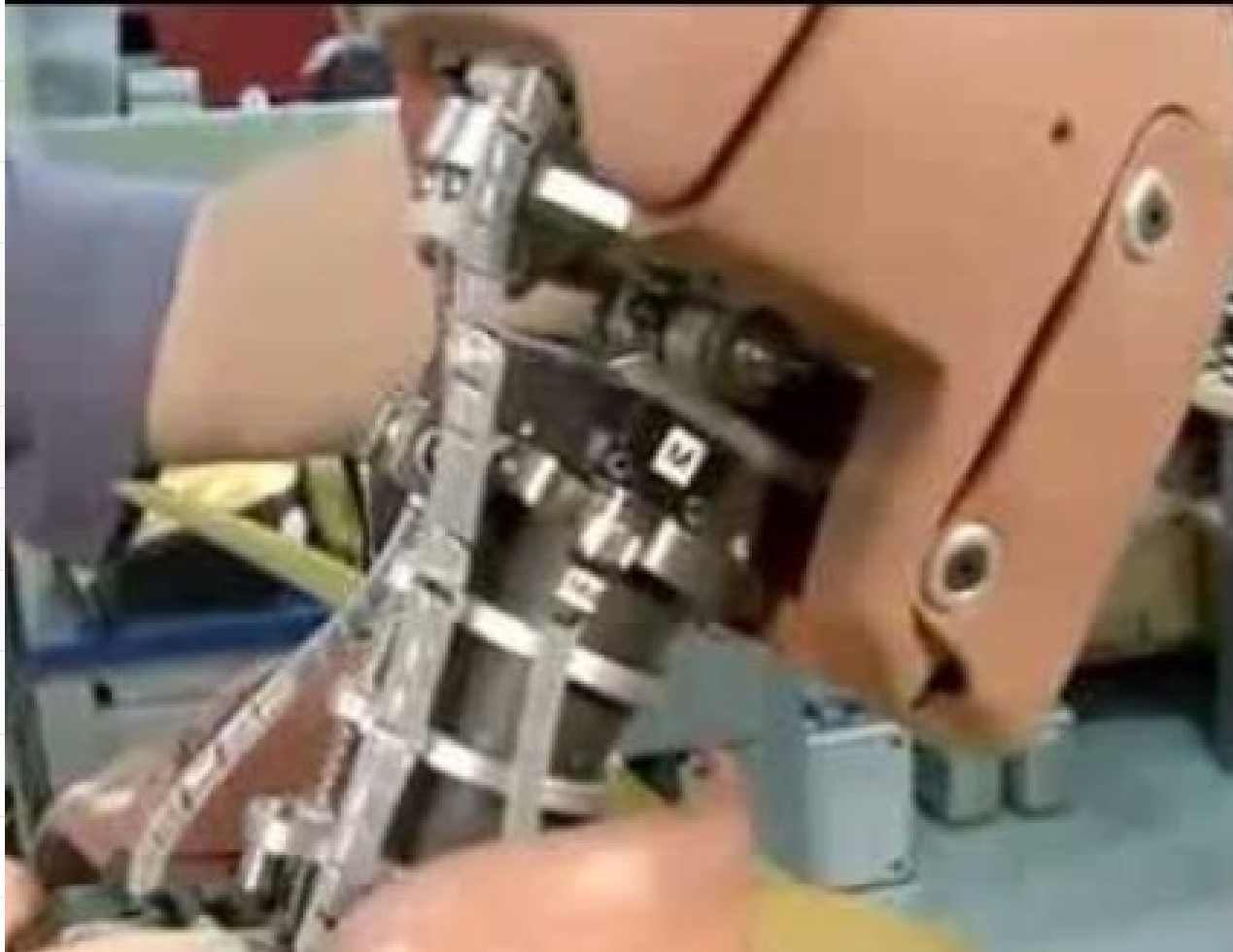

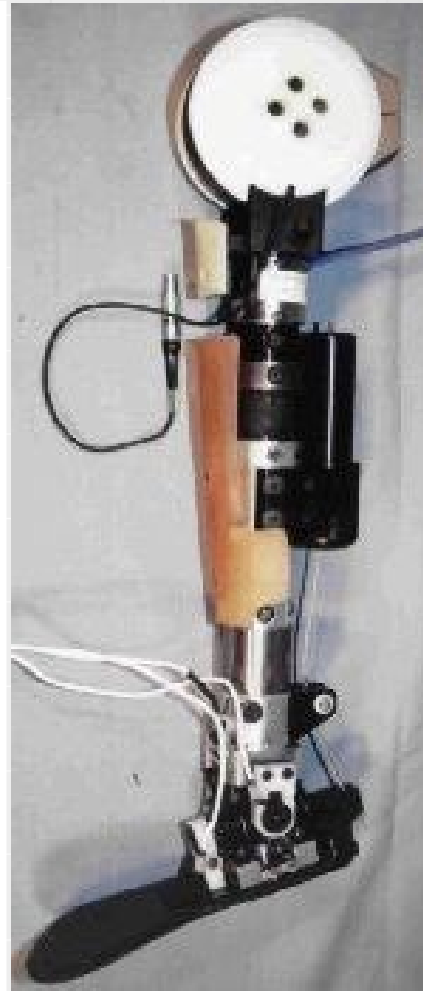
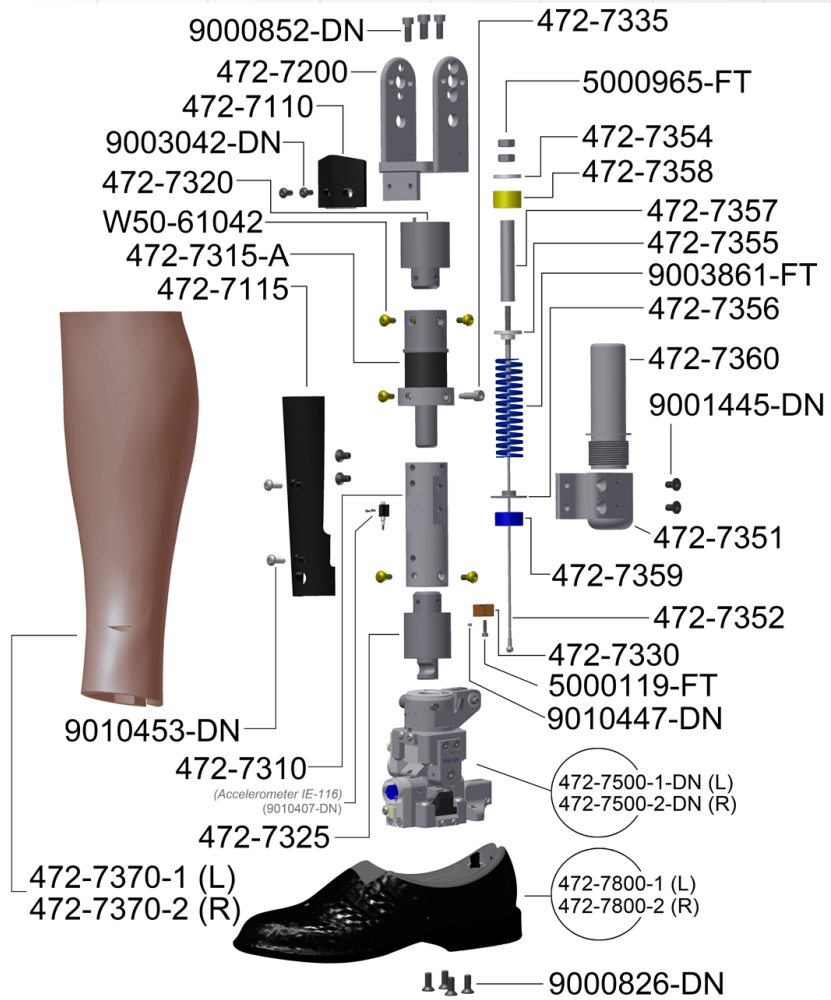

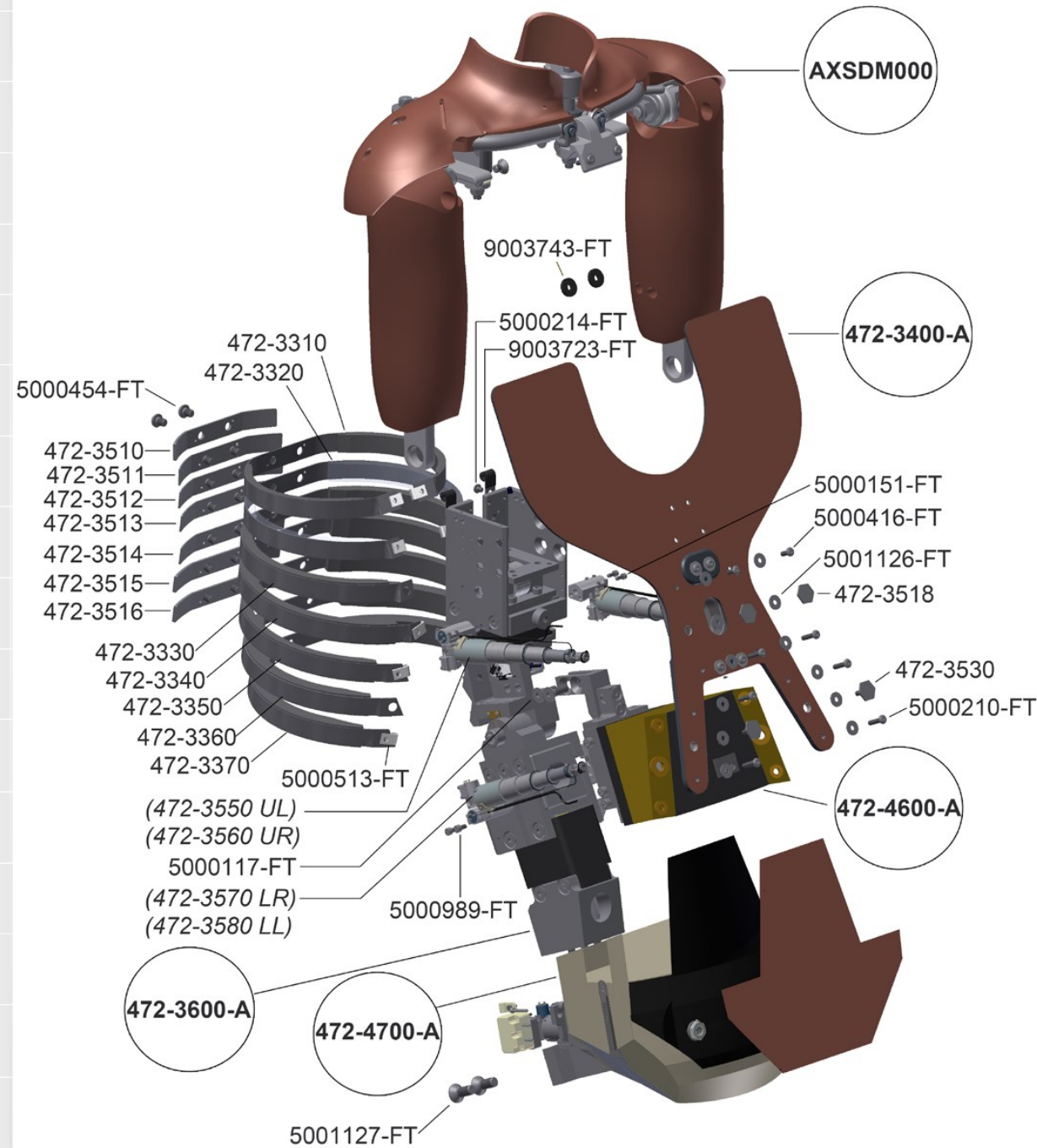

MIRA has developed a method of X-ray imaging of tests at a rate of 1000 frames per second, which enables them to view regions which conventional cameras cannot access, for example around the pedals.

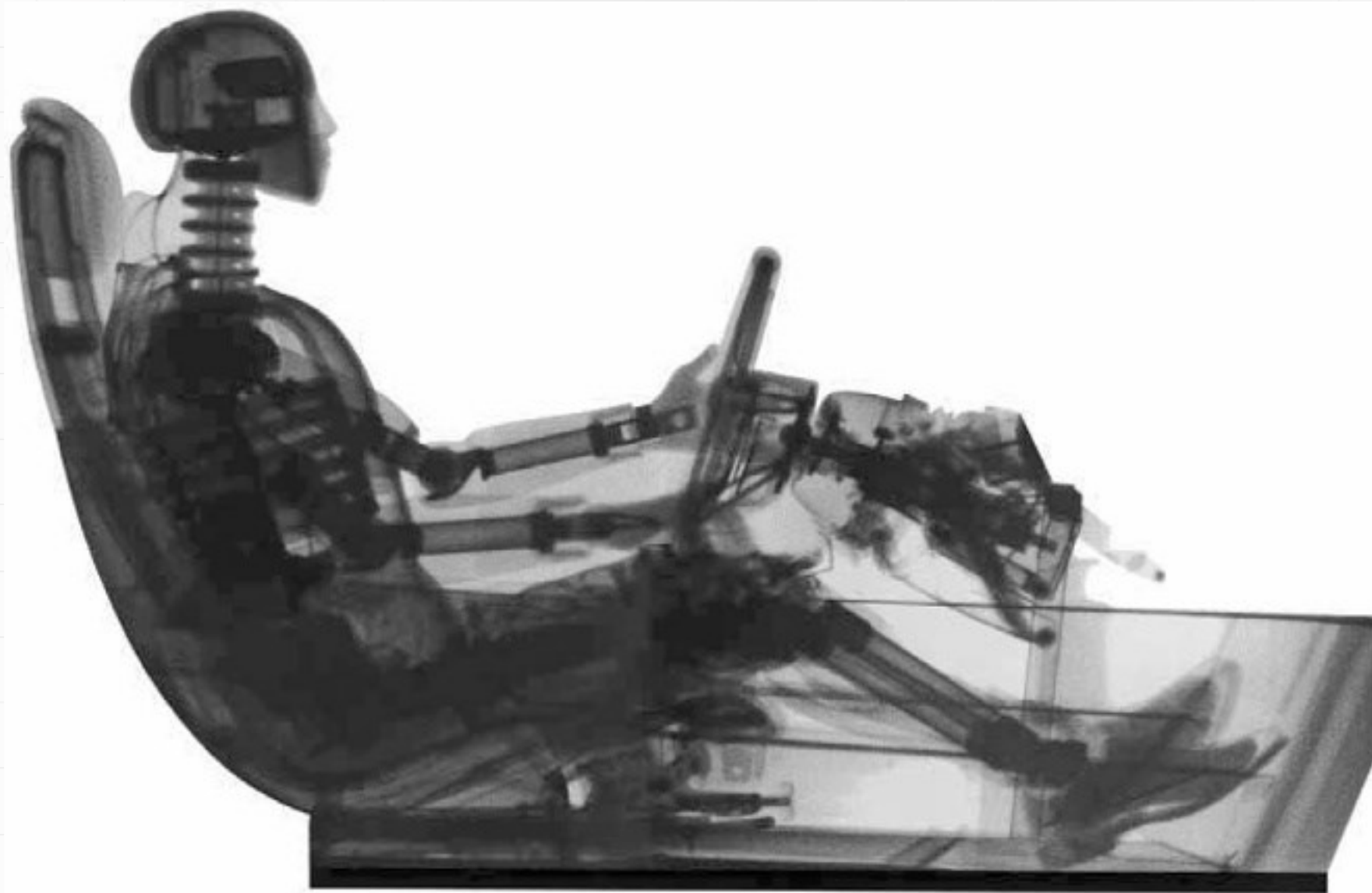

Animal ATD

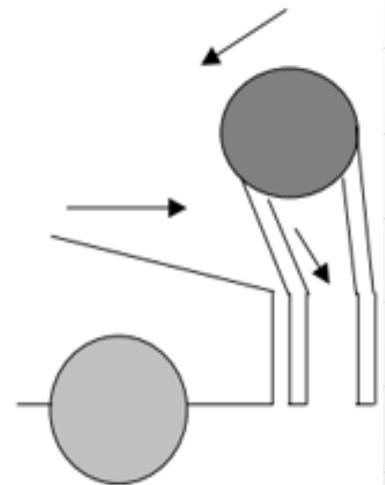
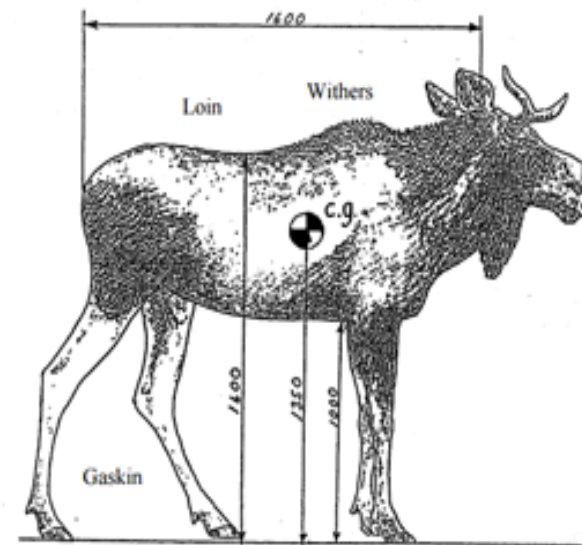

Deformation zone

- Using the barrier load-cell data and vehicle crash data, the energy distribution on the front end can be computed.
- A frame vehicle energy distribution in a high speed rigid barrier test. 35% of the crush energy is absorbed by the upper part of the front end structure, and 65% by the lower part where the frame rails are located.

Energy Management in Frontal Crash

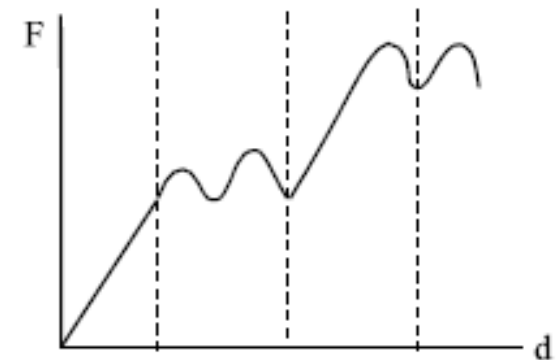
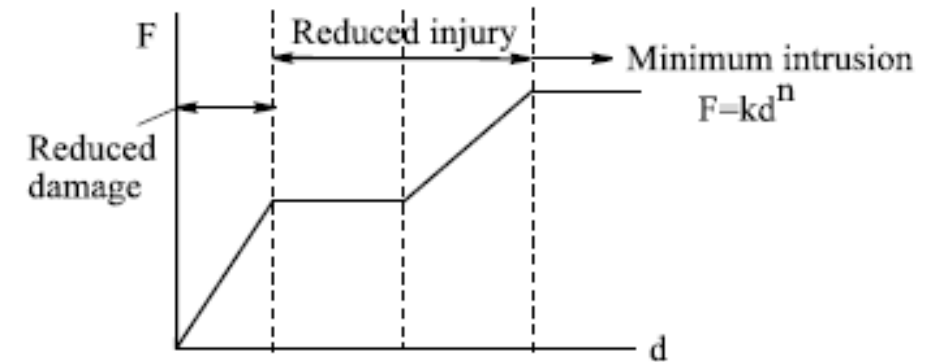
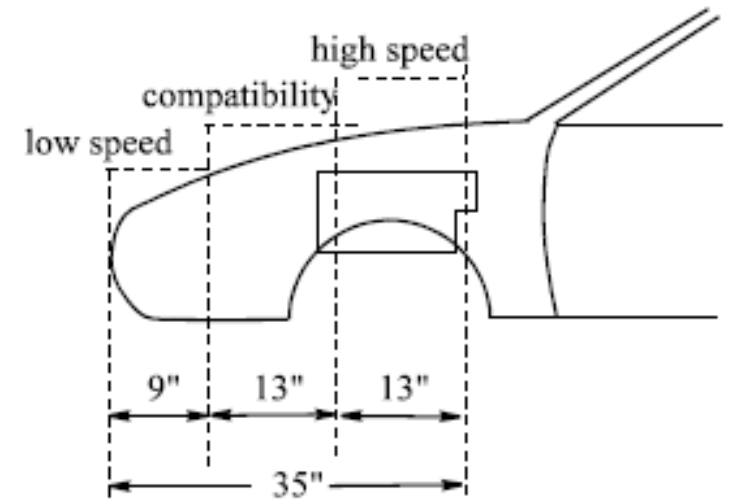
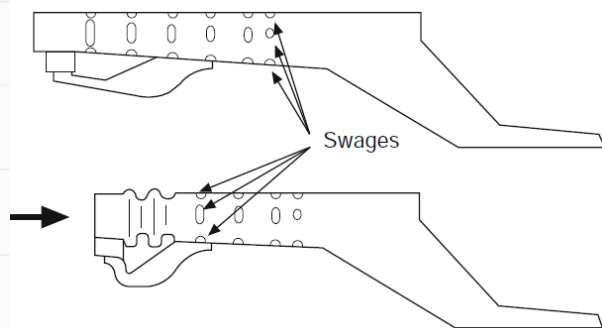
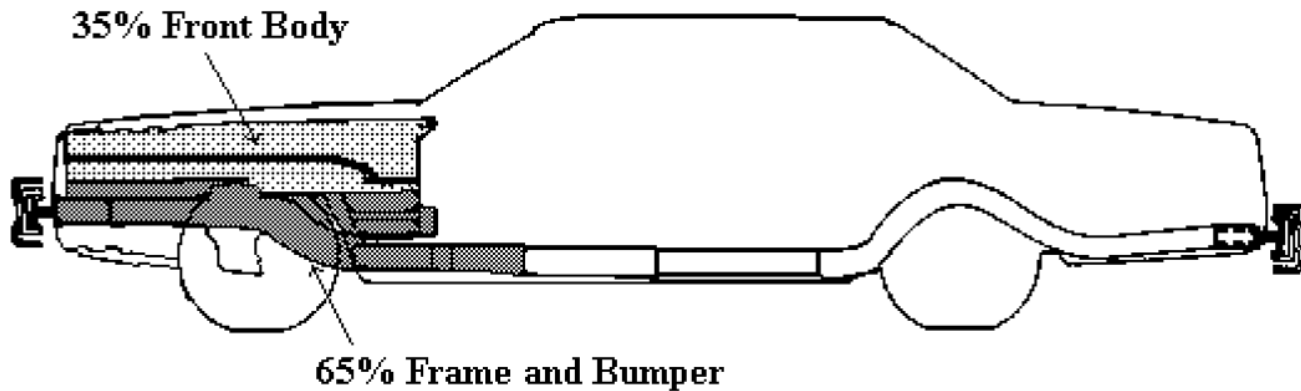

Objectives of body structure

1. to incorporate crush zones at the each end of the car;
2. stiffen the door and its immediate surroundings so that, in the event of a side impact, it will not be penetrated or deflected violently inwards and strike the occupants;
3. the door trim must be soft or side air bags must be installed so that, if the occupants are flung against it by the lateral acceleration, they will not be seriously injured;
4. the door frame and not only its joins but also those between the pillars and cant rail must be strong and stiff enough to react elastically to absorb the shock loading.



Small car

maximum use should be made of transverse members to distribute the loads appropriately between all the longitudinal members, including the body panelling, in a manner such that they are all equally stressed,

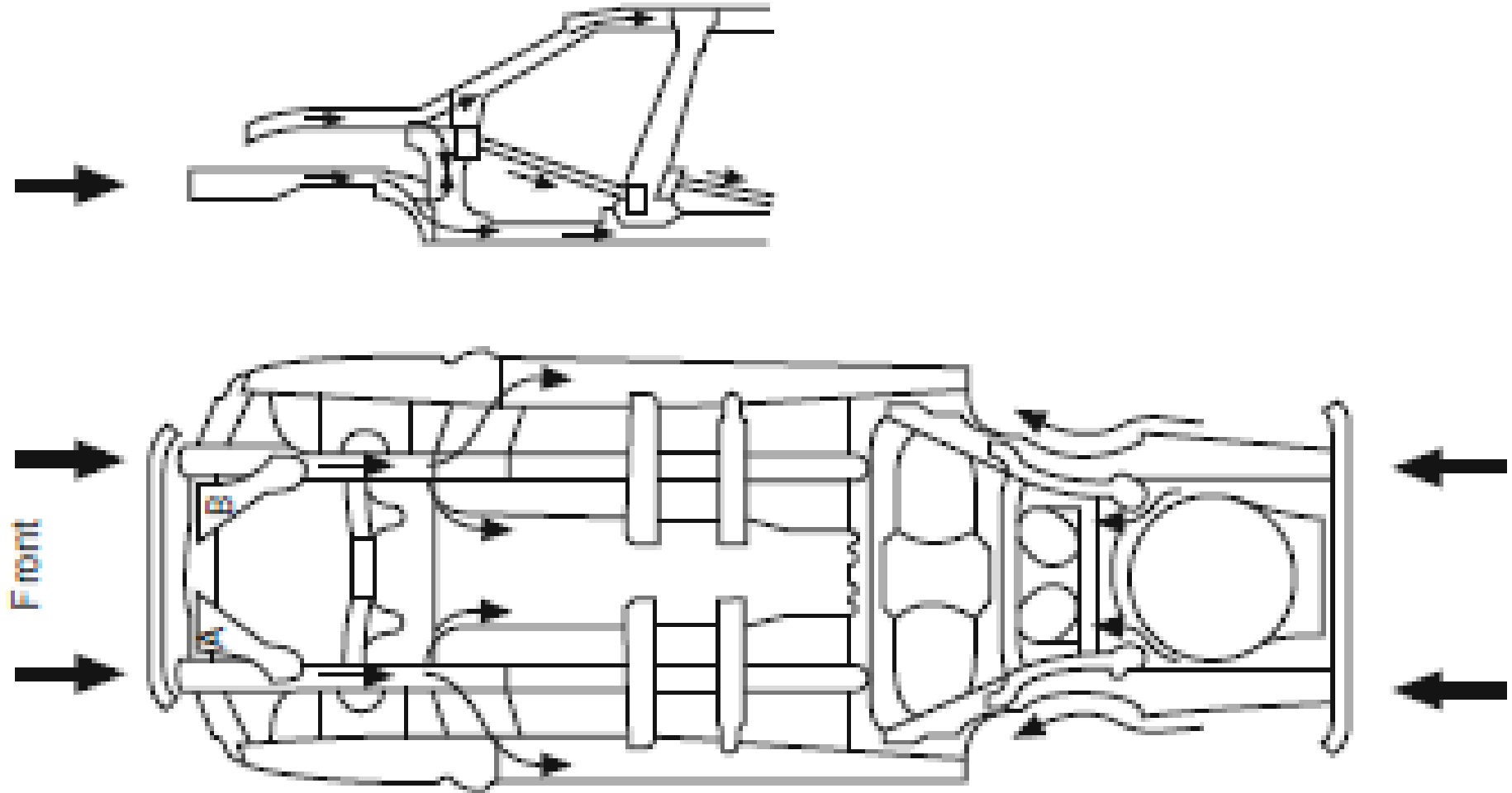

AIS scale

- AIS scale (**A**bbreviated **I**njury **S**cale) has been established in 1969. AIS determines the scale of humans injuries in terms of medicine and contains 6 levels
 1. **AIS = 1** minor injuries (bruising, skin sore, broken nose, broken ribs, cut wounds)
 2. **AIS = 2** medium injuries (deep wounds, concussion with conscious lose for les the 15 minutes, broken breastbone, extensive ribs braking)
 3. **AIS = 3** major injuries (concussion with conscious lose for more then one hour, broken shoulder, broken diaphragm)
 4. **AIS =4** heavy injuries (apoplexy with conscious lose for less then 24 hours, spleen injure, stomach injure, the leg loss above the knee)
 5. **AIS = 5** critical injuries (apoplexy with conscious lose for more then 24 hours, intestine injure, liver injure, hart injure, spine injure)
 6. **AIS =6** deathly injuries (skull brake, chest squash, spine injure above third vertebra)
- The AIS scale is also used to determine the cars' velocity during the pedestrian impact. It also apply to the situation in which the passenger compartment intrusion occurs.
- Based on random 66 test the empirical equation describing relationship between the AIS scale and cars' velocity during the impact with pedestrian, has been set .

$$AIS = a + bv + cv^2$$

AIS scale

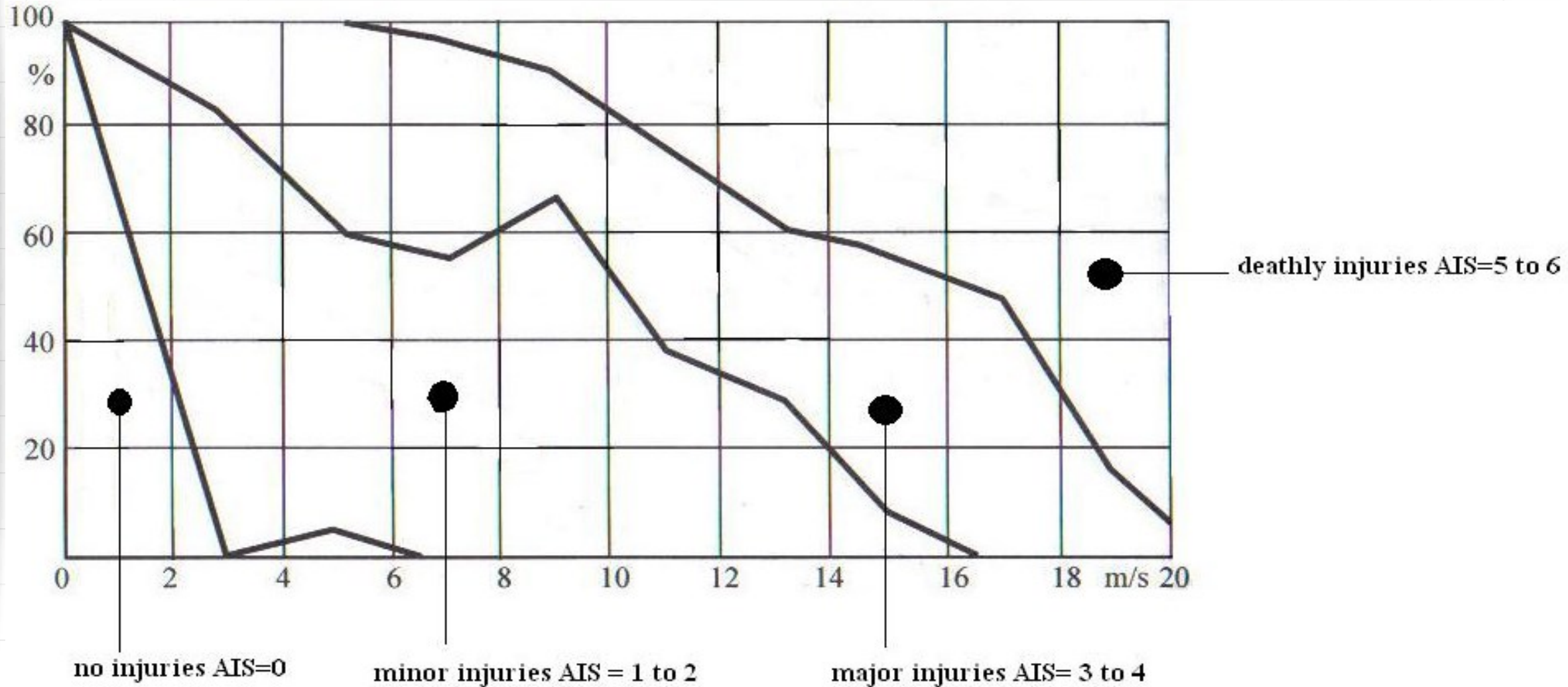

Frontal collision

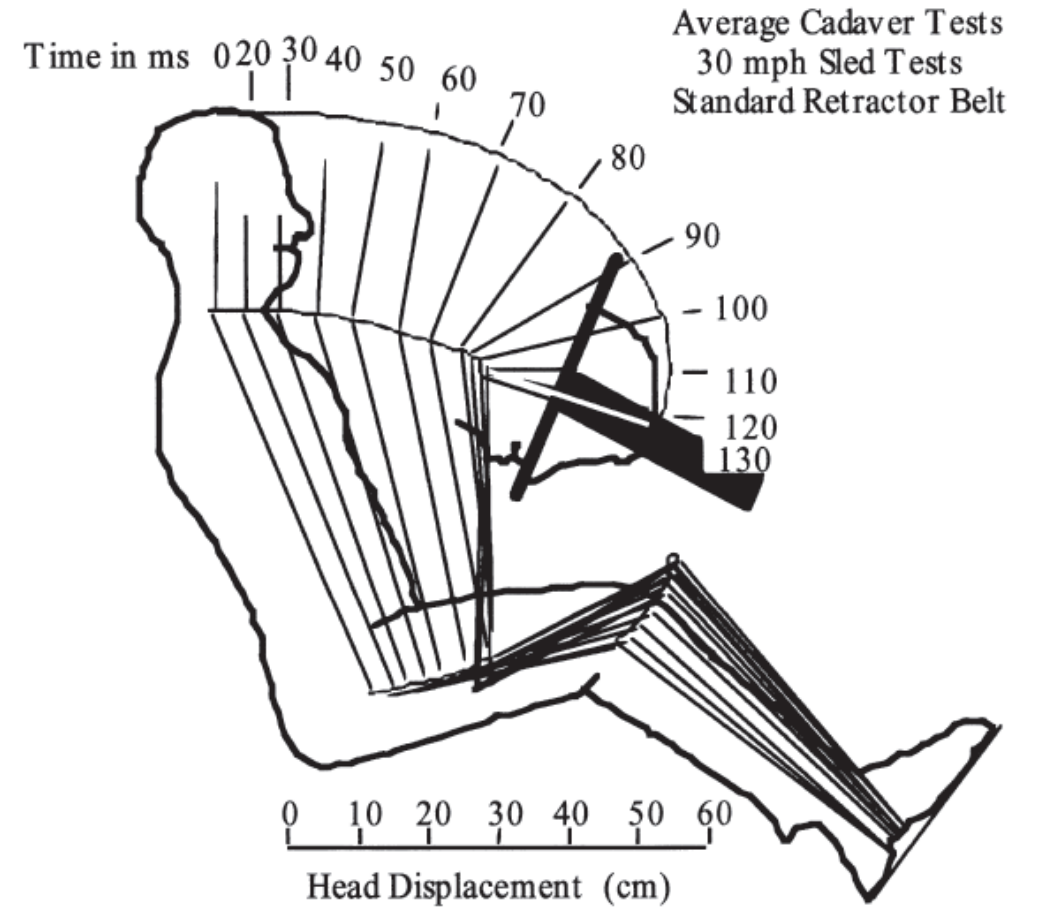
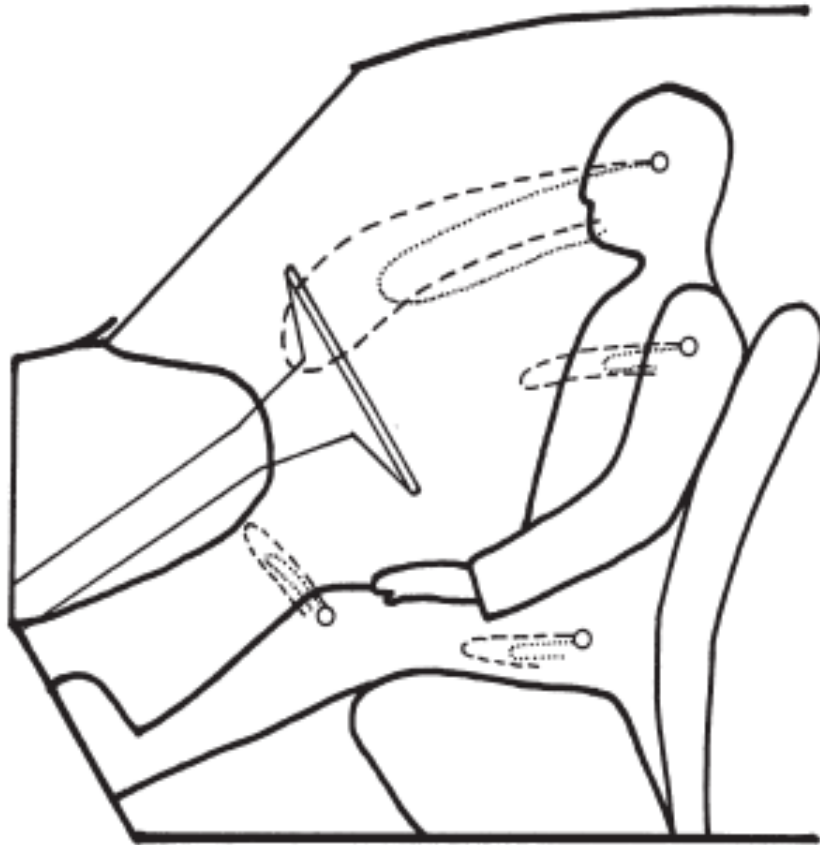

The event of a crash

00 ms : Contact between vehicle and obstacle

10 ms : Safety switch on

23 ms : Main switch on

25 ms : Firing of the propellant, emission of inflating gas starts

28 ms : Cover brakes, bag starts to deploy

40 ms : Occupant body starts to move in relation to the passenger compartment

55 ms : The bag is fully deployed

60 ms : Contact between the chest and the bag

70 ms : Contact between the head and the bag.

95 ms : Maximum of head and chest acceleration

150 ms : The bag is deflating

Pyrotechnically driven devices

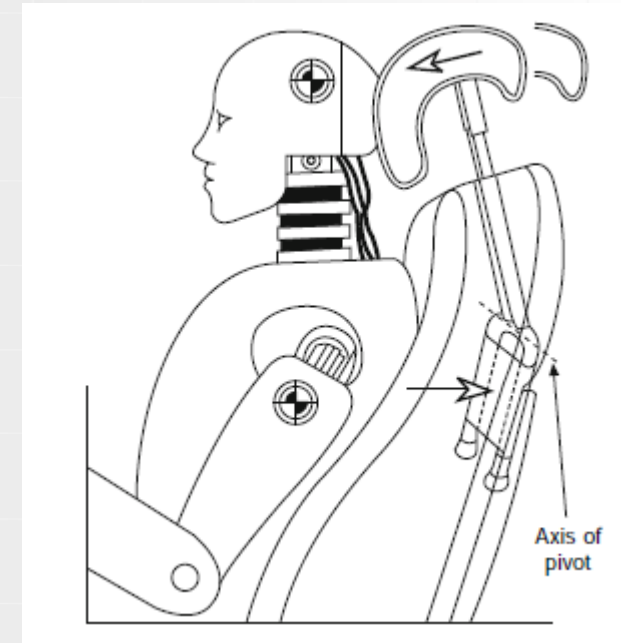
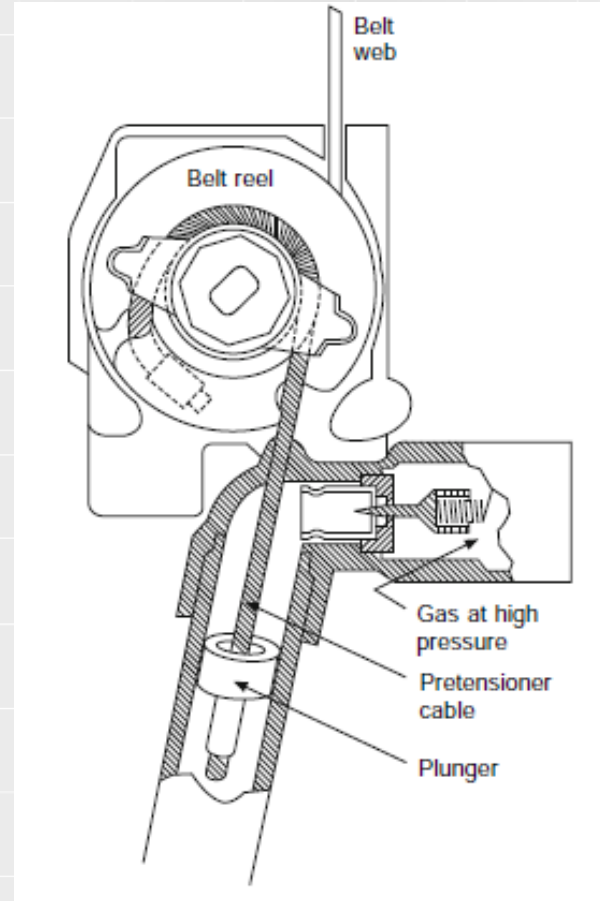
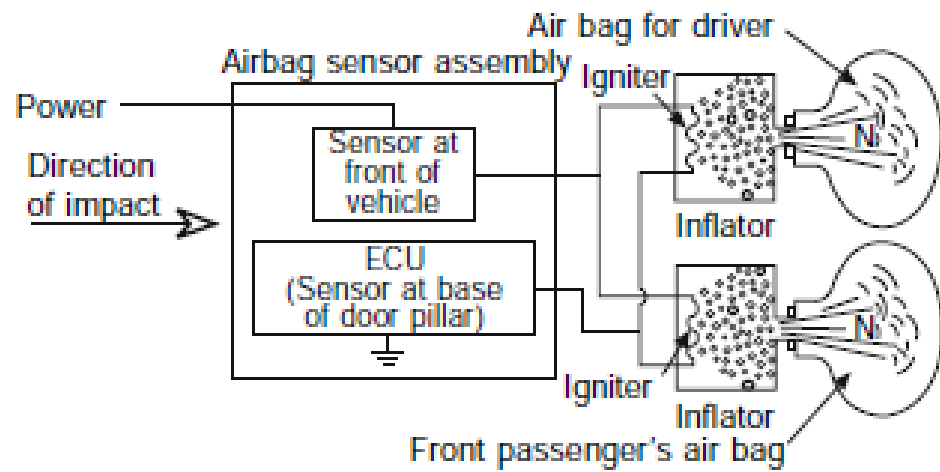
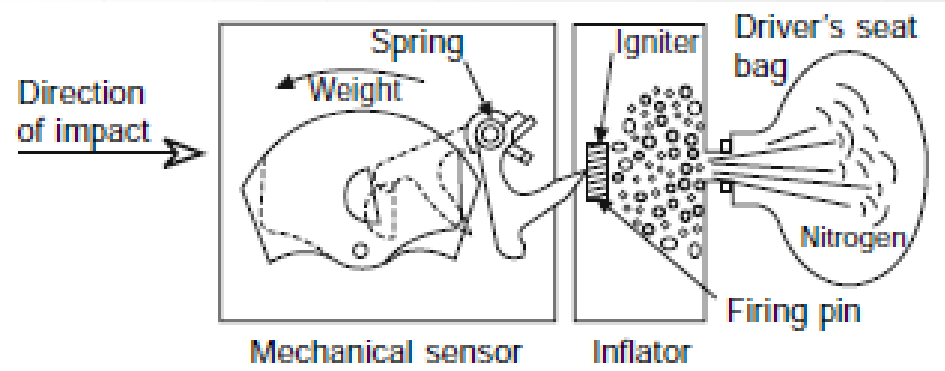

Sled testing

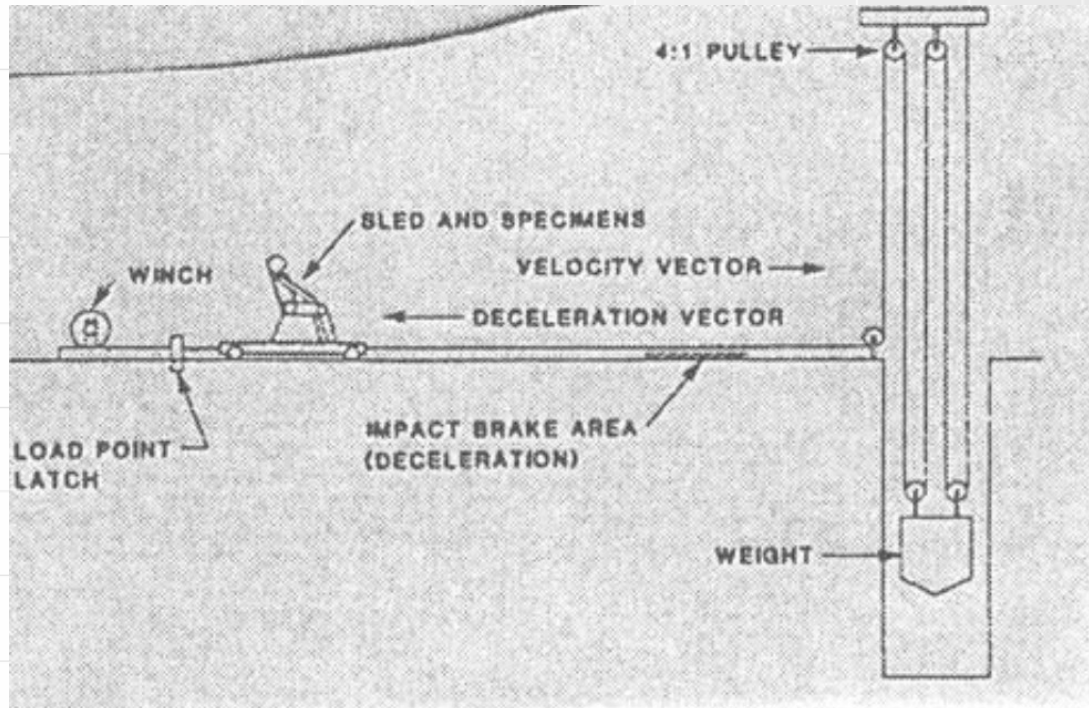
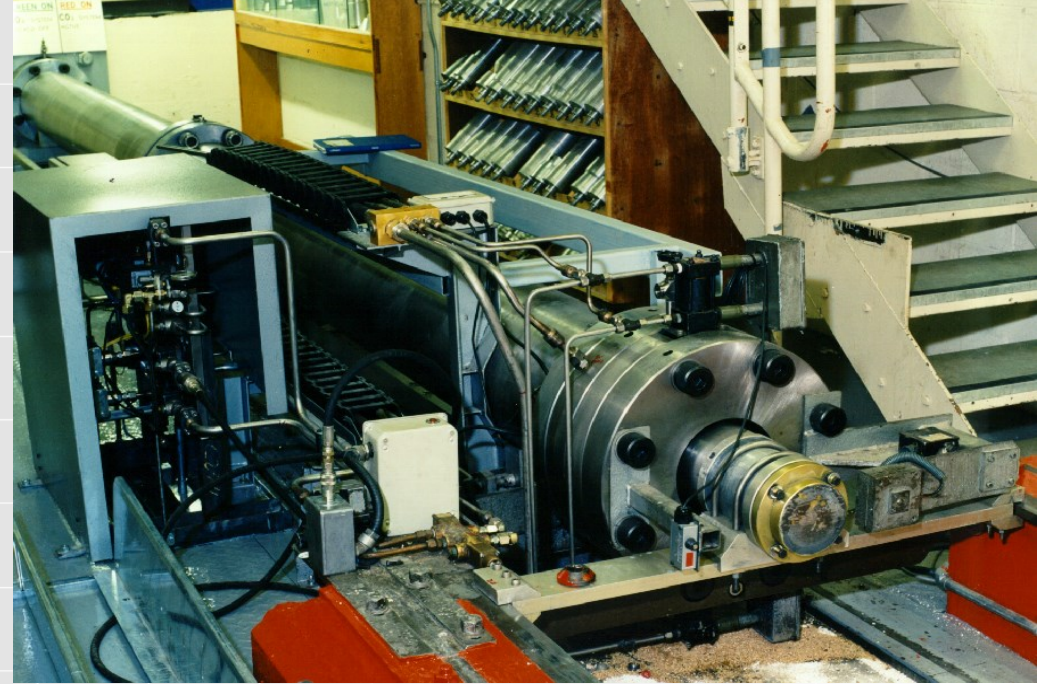

Surrogate testing

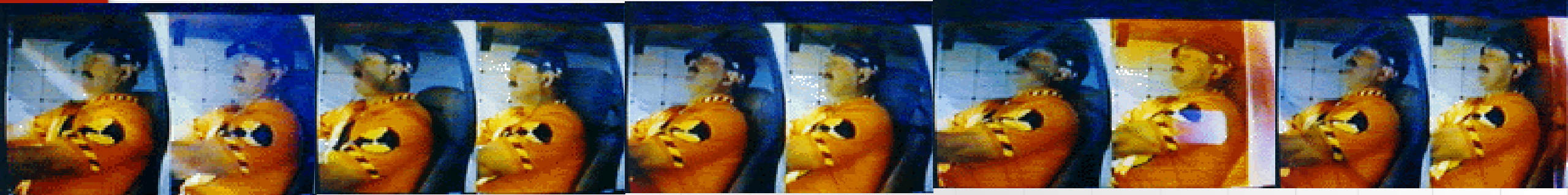



Vehicle compatibility

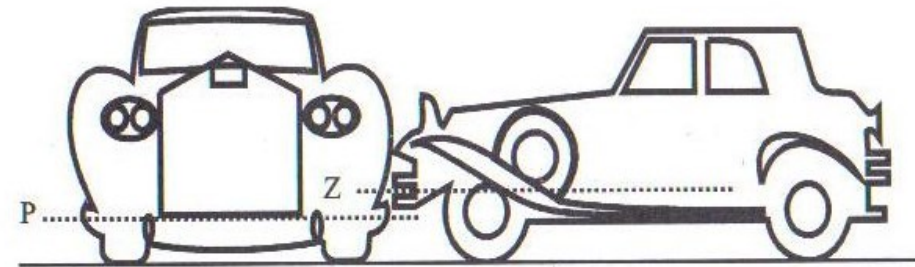
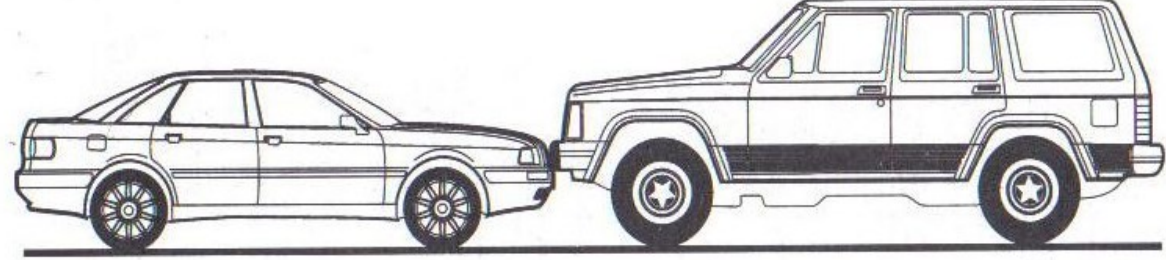
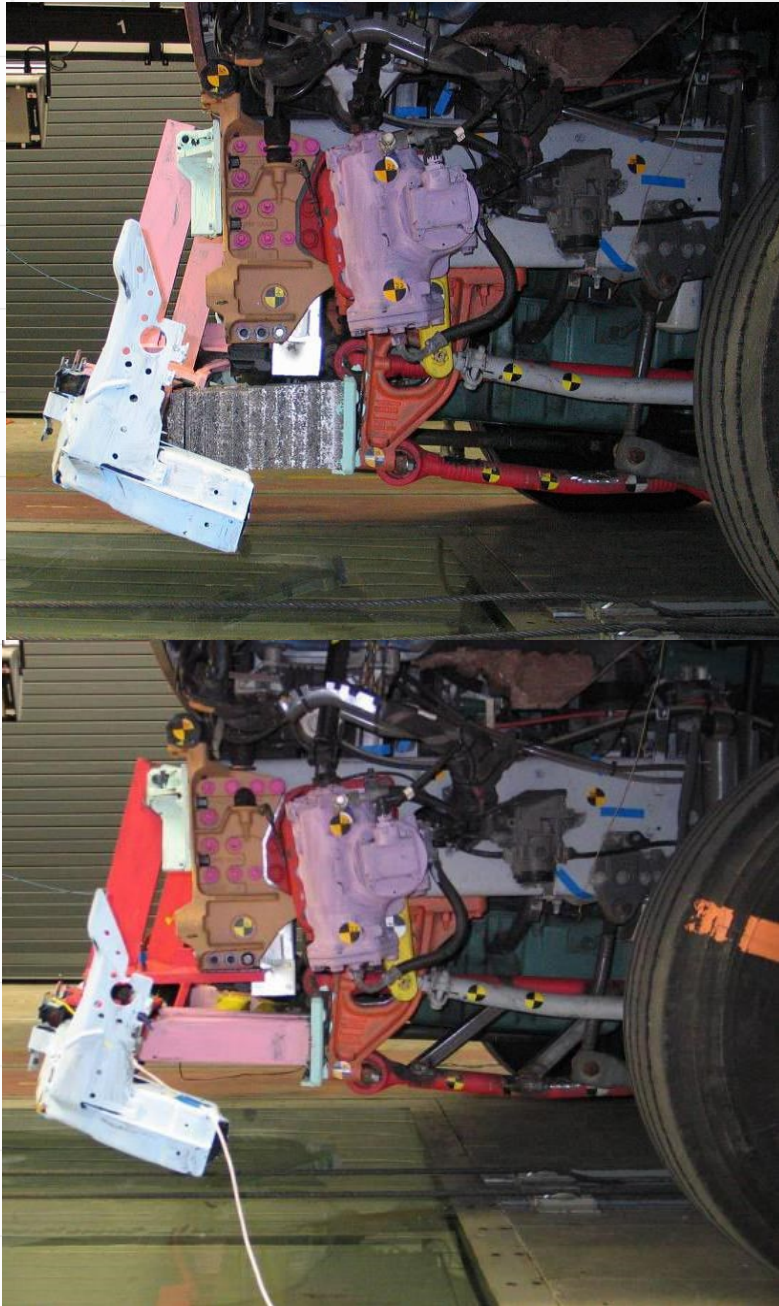

P-threshold

Z-stringer

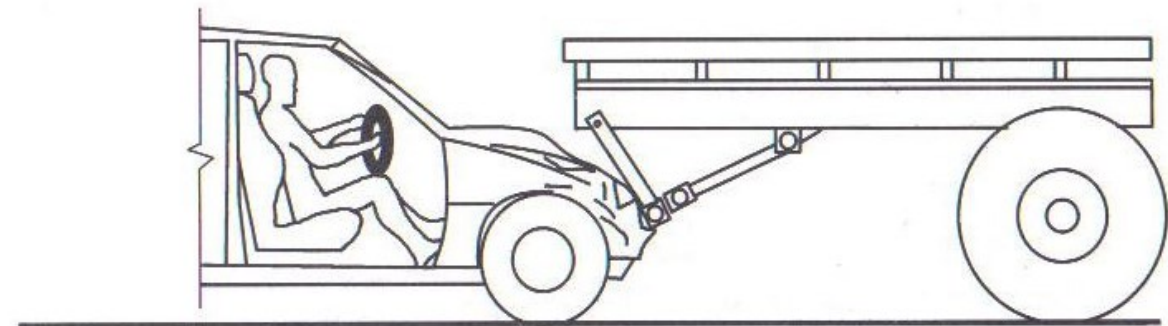
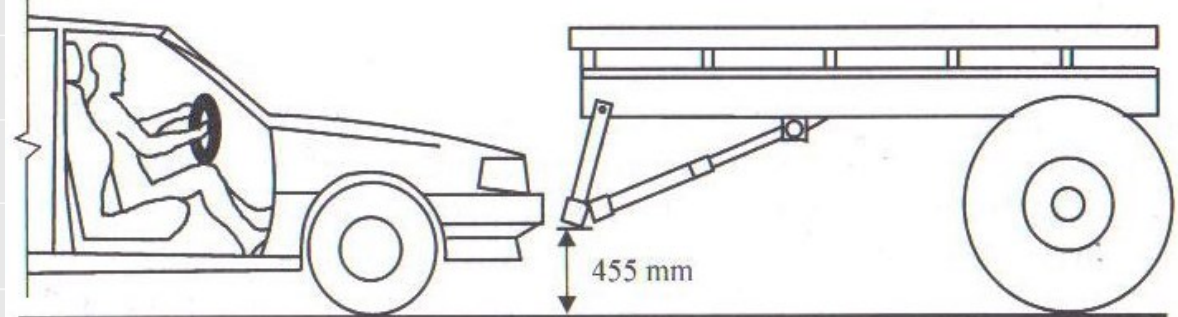

Vehicle compatibility



Heavy duty crash testing

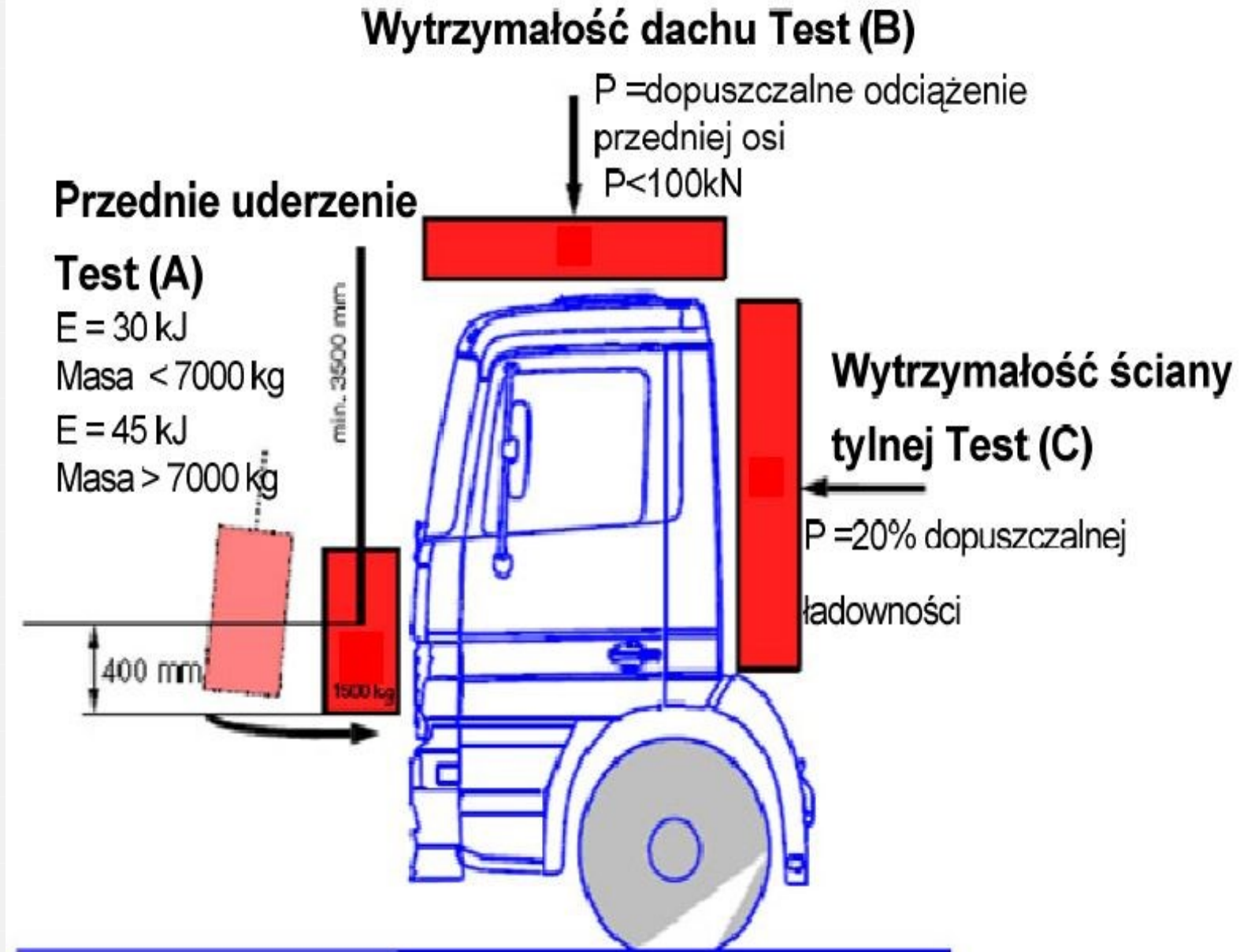

Literature

1. AMBRÓSIO, J. A. C., PEREIRA, M. F. O. S. & DA SILVA, F. P. 2012. *Crashworthiness of Transportation Systems: Structural Impact and Occupant Protection*, Springer Netherlands.
2. BONNICK, A. 2008. *Automotive Science and Mathematics*, Taylor & Francis.
3. HUANG, M. 2002. *Vehicle Crash Mechanics*, CRC Press.
4. WICHER, J. 2002. *Bezpieczeństwo samochodów i ruchu drogowego*, Wydawnictwa Komunikacji i Łączności.
5. CROLLA, D. 2009. *Automotive Engineering e-Mega Reference*, Elsevier Science.
6. HAPPIAN-SMITH, J. 2001. *An Introduction to Modern Vehicle Design*, Butterworth-Heinemann.